

37360B

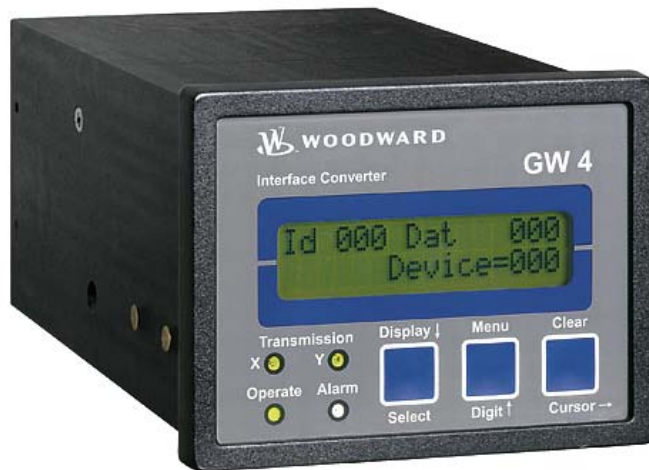

GW 4 Packages Gateway / Interface Converter



Operation Manual
Software Version 2.0xxx

Manual 37360B



WARNING

Read this entire manual and all other publications pertaining to the work to be performed before installing, operating, or servicing this equipment. Practice all plant and safety instructions and precautions. Failure to follow instructions can cause personal injury and/or property damage.

The engine, turbine, or other type of prime mover should be equipped with an overspeed (overtemperature, or overpressure, where applicable) shutdown device(s), that operates totally independently of the prime mover control device(s) to protect against runaway or damage to the engine, turbine, or other type of prime mover with possible personal injury or loss of life should the mechanical-hydraulic governor(s) or electric control(s), the actuator(s), fuel control(s), the driving mechanism(s), the linkage(s), or the controlled device(s) fail.

Any unauthorized modifications to or use of this equipment outside its specified mechanical, electrical, or other operating limits may cause personal injury and/or property damage, including damage to the equipment. Any such unauthorized modifications: (i) constitute "misuse" and/or "negligence" within the meaning of the product warranty thereby excluding warranty coverage for any resulting damage, and (ii) invalidate product certifications or listings.



CAUTION

To prevent damage to a control system that uses an alternator or battery-charging device, make sure the charging device is turned off before disconnecting the battery from the system.

Electronic controls contain static-sensitive parts. Observe the following precautions to prevent damage to these parts.

- Discharge body static before handling the control (with power to the control turned off, contact a grounded surface and maintain contact while handling the control).
- Avoid all plastic, vinyl, and Styrofoam (except antistatic versions) around printed circuit boards.
- Do not touch the components or conductors on a printed circuit board with your hands or with conductive devices.



OUT-OF-DATE PUBLICATION

This publication may have been revised or updated since this copy was produced. To verify that you have the latest revision, be sure to check the Woodward website:

<http://www.woodward.com/pubs/current.pdf>

The revision level is shown at the bottom of the front cover after the publication number. The latest version of most publications is available at:

<http://www.woodward.com/publications>

If your publication is not there, please contact your customer service representative to get the latest copy.

Important definitions



WARNING

Indicates a potentially hazardous situation that, if not avoided, could result in death or serious injury.



CAUTION

Indicates a potentially hazardous situation that, if not avoided, could result in damage to equipment.



NOTE

Provides other helpful information that does not fall under the warning or caution categories.

Woodward reserves the right to update any portion of this publication at any time. Information provided by Woodward is believed to be correct and reliable. However, Woodward assumes no responsibility unless otherwise expressly undertaken.

© Woodward
All Rights Reserved.

Revision History

Rev.	Date	Editor	Changes
NEW	05-10-07	TP	Release based on 37133C
A	07-03-29	TP	Minor corrections
B	08-11-25	TE	Minor corrections

Content

CHAPTER 1. GENERAL INFORMATION.....	6
Related Documents.....	6
Overview	6
CHAPTER 2. ELECTROSTATIC DISCHARGE AWARENESS	7
CHAPTER 3. HOUSING	8
Dimensions	8
CHAPTER 4. CONNECTION	9
Wiring Diagram GW4/232	9
Wiring Diagram GW4/485	10
Wiring Diagram GW4/232/LDP/MDM02	11
Wiring Diagram GW4/PRO	12
Power Supply	13
Interfaces	13
Interface with Woodward Units	13
Interface with External Participants	14
CHAPTER 5. FUNCTIONAL DESCRIPTION	15
GW4/232	15
Functional Overview	15
GW 4/232/MOD [Modbus RTU Slave].....	15
GW 4/232/LDP [Leonhard Data Protocol]	16
GW 4/485.....	17
Functional Overview	17
GW 4/485/MOD [Modbus RTU Slave].....	17
GW 4/232/LDP/MDM02	18
Functional Overview	18
GW 4/PRO	19
Functional Overview	19
Remote Monitoring (Measured Value Display).....	19
Remote Control (Sending Set Point Values/Control Commands).....	19
Remote Configuration (Changing Non-Volatile Parameters)	20
Notes.....	20
Parameter	21
Machine Bus Monitoring For GW 4/xxx/MOD.....	22

CHAPTER 6. DISPLAY AND CONTROL ELEMENTS 23

Front Panel 23

LEDs 24

LC Display 24

 Automatic Mode (First Display Line) 24

 Automatic Mode (Second Display Line) 24

Push Buttons 25

CHAPTER 7. CONFIGURATION..... 26

General Configuration Screens 26

Data Transmission Mode..... 28

Configuration Expansion (Sub-Units) 29

CHAPTER 8. TECHNICAL DATA 30

CHAPTER 9. DATA CONNECTION 31

Coupling via GW 4/232..... 31

Coupling via GW 4/485..... 32

Coupling via GW 4/232/LDP/MDM02 33

Coupling via GW 4/PRO 34

APPENDIX A. PRACTICAL APPLICATIONS 35

Structure of the GW 4 35

The CAN Interface..... 35

 General Information..... 35

 Settings for Receiving CAN Messages 35

 Size of the Receive Blocks..... 36

 Sending CAN Messages 36

The Profibus Interface 38

Modbus 38

 Modbus Monitoring..... 38

 Sending Data..... 39

LDP Protocol..... 39

Modem..... 39

Several GW4s at one CAN Bus..... 39

APPENDIX B. APPLICATION RESTRICTIONS..... 40

APPENDIX C. DATA ASSIGNMENT TABLE 41

Receiving Table of the GW 4..... 41

Transmission Table of the GW 4 43

APPENDIX D. PARAMETER LIST 44

APPENDIX E. DECLARATION OF CONFORMITY..... 45

APPENDIX F. SERVICE OPTIONS..... 47

Product Service Options..... 47

Returning Equipment For Repair..... 47

 Packing a Control 48

 Return Authorization Number RAN 48

Replacement Parts 48

How To Contact Woodward..... 49

Engineering Services..... 50

Technical Assistance..... 51

Illustrations and Tables

Illustrations

Figure 3-1: Dimensions GW4	8
Figure 4-1: Wiring diagram GW4/232	9
Figure 4-2: Wiring diagram GW4/485	10
Figure 4-3: Wiring diagram GW4/MDM02	11
Figure 4-4: Wiring diagram GW4/PRO	12
Figure 4-5: Power supply	13
Figure 4-7: Interface - CAN bus	13
Figure 4-8: CAN bus - connection scheme	14
Figure 4-9: Interfaces (external)	14
Figure 6-1: Front panel	23
Figure 9-1: Data coupling - GW4/232	31
Figure 9-2: Data coupling - GW4/485	32
Figure 9-3: Data coupling - GW4/MDM02	33
Figure 9-4: Data coupling - GW4/PRO	34

Tables

Table 1-1: Manual - overview	6
Table 4-1: Power supply- terminal assignment	13
Table 4-3: Interfaces (external) - terminal assignment	14

Chapter 1. General Information



Related Documents



Type	English	German
Gateway GW4		
GW 4 Packages Manual	this manual ⇨	37360 GR37360

Table 1-1: Manual - overview

Overview



This operation manual describes the following types of the Gateway GW 4:

- GW 4B/485/MOD
- GW 4B/232/MOD
- GW 4/PRO
- GW 4/232/LDP/MDM02
- GW 4B/232/LDP

Please refer to the name plate of your Gateway GW 4 to establish the correct type. The different units allow different protocols. They depend on the used hardware.

Intended Use The control must only be operated according to the guidelines described in this manual. The prerequisite for a proper and safe operation of the product is correct transportation, storage, and installation as well as careful operation and maintenance.



NOTE

This manual has been developed for an control fitted with all available options. Inputs/outputs, functions, configuration screens, and other details described, which do not exist on your control, may be ignored.

The present manual has been prepared to enable the installation and commissioning of the control. Due to the large variety of parameter settings, it is not possible to cover every combination. The manual is therefore only a guide. In case of incorrect entries or a total loss of functions, the default settings may be taken from the enclosed list of parameters.

Chapter 2.

Electrostatic Discharge Awareness

All electronic equipment is static-sensitive, some components more than others. To protect these components from static damage, you must take special precautions to minimize or eliminate electrostatic discharges.

Follow these precautions when working with or near any control.

1. Before doing maintenance on the electronic control, discharge the static electricity on your body to ground by touching and holding a grounded metal object (pipes, cabinets, equipment, etc.).
2. Avoid the build-up of static electricity on your body by not wearing clothing made of synthetic materials. Wear cotton or cotton-blend materials as much as possible because these do not store static electric charges as easily as synthetics.
3. Keep plastic, vinyl, and Styrofoam materials (such as plastic or Styrofoam cups, cigarette packages, cellophane wrappers, vinyl books or folders, plastic bottles, etc.) away from the control, modules, and work area as much as possible.
4. **Opening the control cover may void the unit warranty.**
Do not remove the printed circuit board (PCB) from the control cabinet unless absolutely necessary. If you must remove the PCB from the control cabinet, follow these precautions:
 - Ensure that the device is completely voltage-free (all connectors have to be disconnected).
 - Do not touch any part of the PCB except the edges.
 - Do not touch the electrical conductors, connectors, or components with conductive devices or with bare hands.
 - When replacing a PCB, keep the new PCB in the plastic antistatic protective bag it comes in until you are ready to install it. Immediately after removing the old PCB from the control cabinet, place it in the antistatic protective bag.



CAUTION

To prevent damage to electronic components caused by improper handling, read and observe the precautions in Woodward manual 82715, *Guide for Handling and Protection of Electronic Controls, Printed Circuit Boards, and Modules*.

Chapter 3. Housing

Dimensions



Housing	Typ APRANORM DIN 43700
Dimensions	96 × 72 × 130 mm
Front panel cutout	91 × 67 mm
Wiring	Screw-type terminals, depending on connector 1,5 mm ² or 2,5 mm ²
Protection class	IP 21, from front IP45
Weight	depending on version, approx. 500 g

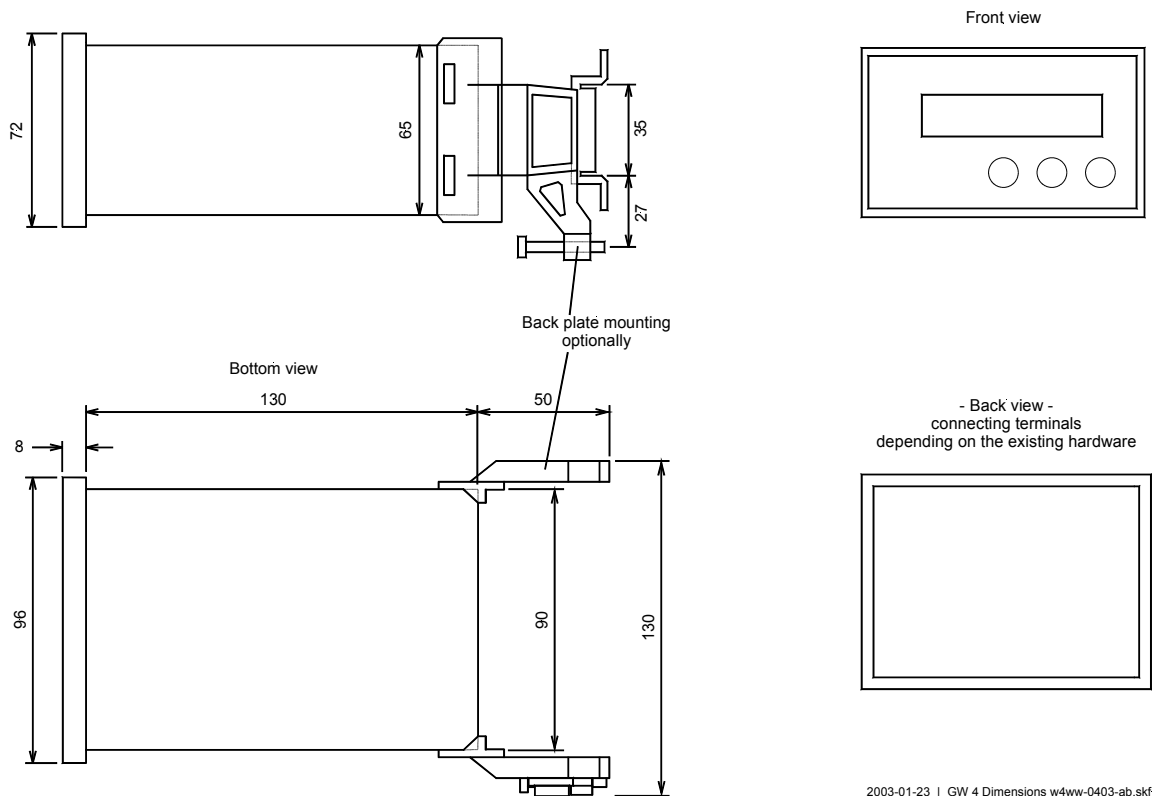

2003-01-23 | GW 4 Dimensions w4ww-0403-ab.skf

Figure 3-1: Dimensions GW4

Chapter 4. Connection

Wiring Diagram GW4/232

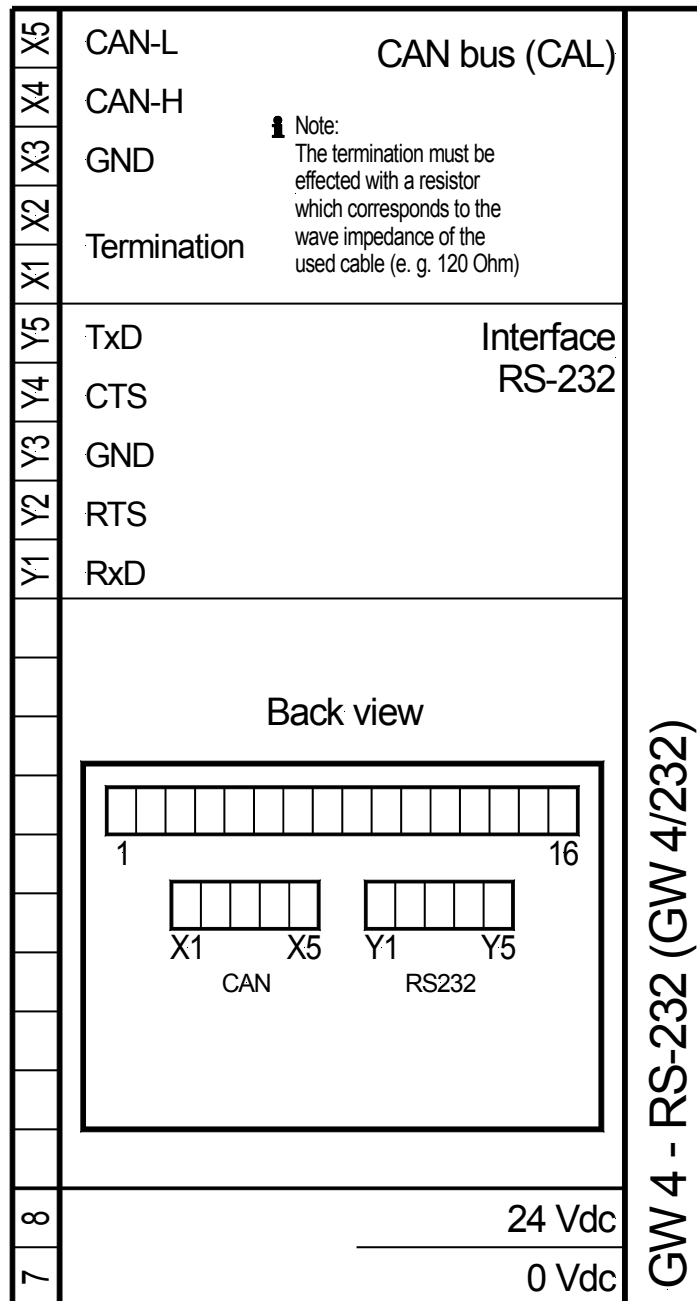

Subject to technical modifications.

2004-10-04 | GW 4-232 Wiring Diagram w4rs232ww-0445-ap.skf

Figure 4-1: Wiring diagram GW4/232

Wiring Diagram GW4/485

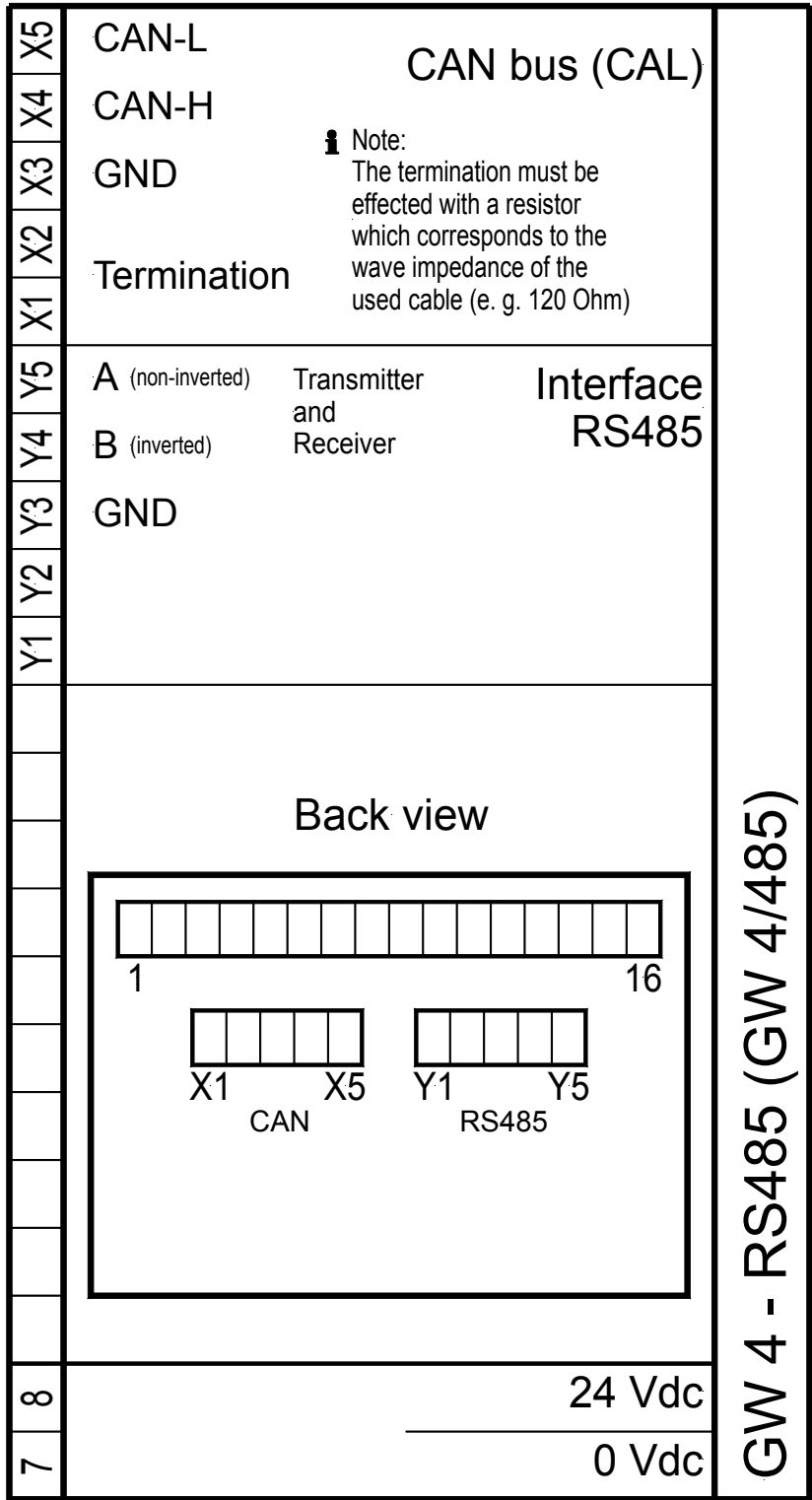

GW 4 - RS485 (GW 4/485)

Subject to technical modifications. 2003-01-23 | GW 4-485 Wiring Diagram w4rs485ww-0403-ap.skf

Figure 4-2: Wiring diagram GW4/485

Wiring Diagram GW4/PRO

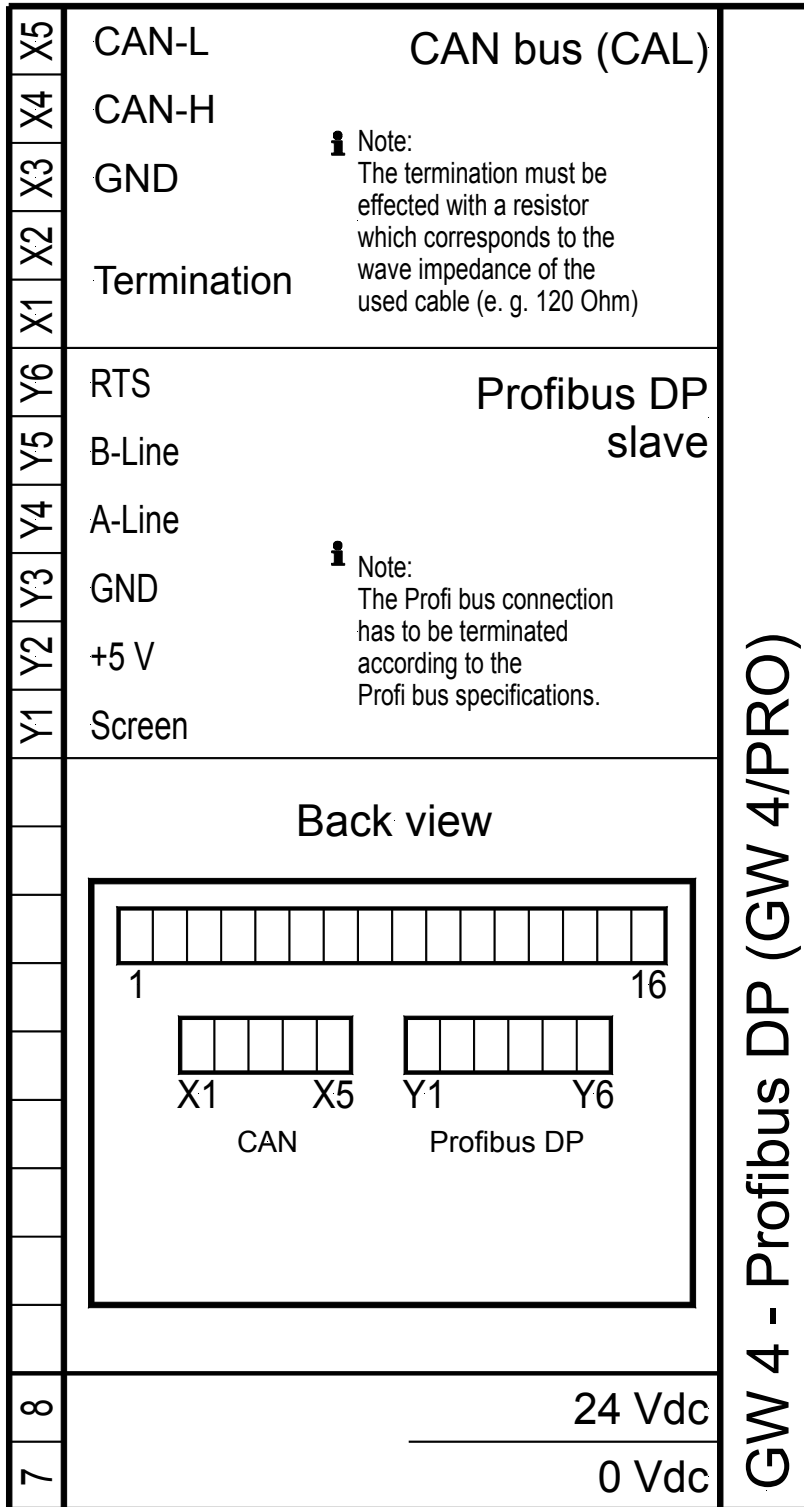

GW 4 - Profibus DP (GW 4/PRO)

Subject to technical modifications.

2003-01-23 | GW 4-PRO Wiring Diagram w4proww-0403-ap.skf

Figure 4-4: Wiring diagram GW4/PRO

Power Supply

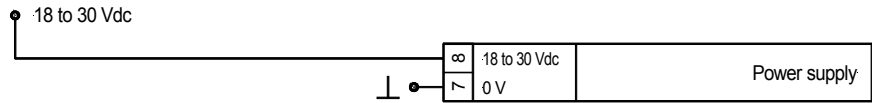

Figure 4-5: Power supply

Terminal	Description	A _{max}
7	0 V reference potential	2.5 mm ²
8	18 to 30 Vdc, max. 10 W	2.5 mm ²

Table 4-1: Power supply- terminal assignment

Interfaces



Interface with Woodward Units

The interface with connected Woodward units is established via the CAN bus.

Terminal					Description
X1	X2	X3	X4	X5	
CAN-H	CAN-L	GND	CAN-H	CAN-L	CAN bus

Table 4-2: CAN interface (Woodward) - terminal assignment

	X1	X2	X3	X4	X5
Termination			GND	CAN-H	CAN-L
Interface CAN bus					

Figure 4-6: Interface



NOTE

Please note that the CAN bus must be terminated with an impedance which corresponds to the wave impedance of the cable (e.g. 120 Ohm).

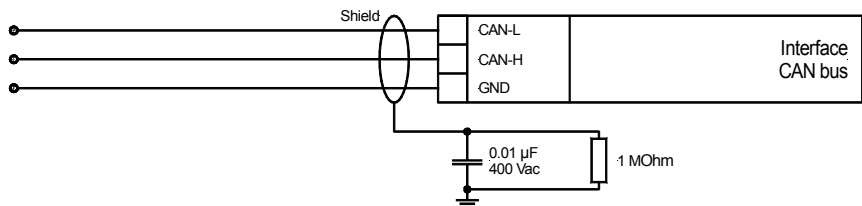

Figure 4-7: Interface - CAN bus

The following must be noted to ensure trouble-free operation of the CAN bus:

- The maximum bus length must not exceed 250 meters.
- The bus must be terminated at each end with terminating resistors that correspond to the wave impedance of the bus cable (approx. 120 Ω).
- The structure of the bus must be linear. Dead-end feeders are not permissible.
- Shielded "Twisted-Pairs" are preferable for use as bus cables (e.g.: Lappkabel Unitronic LIYCY (TP) 2×2×0.25, UNITRONIC-Bus LD 2×2×0.22).
- The bus cable must not be routed in the vicinity of power lines.

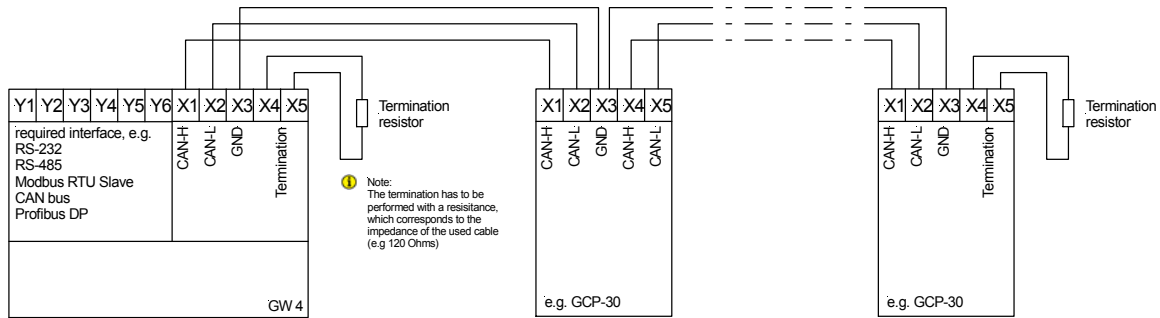

Figure 4-8: CAN bus - connection scheme



NOTE

The CAN bUS terminals X1 and X4 as well as X2 and X5 are wired internally.

Interface with External Participants

The interface with connected external participants may be established via several bus systems or interface protocols.

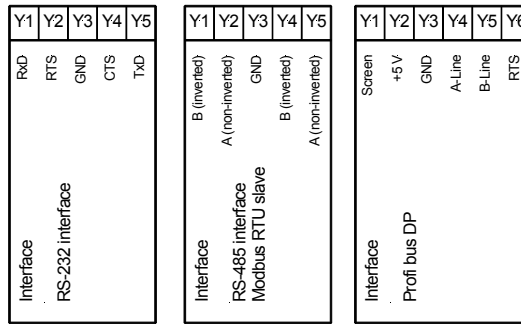

Figure 4-9: Interfaces (external)

Terminal					Description
Y1	Y2	Y3	Y4	Y5	
RxD	RTS	GND	CTS	TxD	RS-232
		GND	B	A	RS-485, Modbus RTU Slave
Y1	Y2	Y3	Y4	Y5	Y6
Shield	+5 V	GND	A line	B line	RTS
Profibus DP (use the file WOOD_V13.GSD)					

Table 4-3: Interfaces (external) - terminal assignment

Chapter 5.

Functional Description



ATTENTION

The supply voltage (24 Vdc) for the GW 4 Gateway must not be connected directly to the engine's starter battery.

The following occurs if the unit is started by remote starting via the GW 4 Gateway from the control room/PLC: If the starter is energized, the supply voltage of the GW 4 Gateway can fall below 18 Vdc. As a result, the GW 4 Gateway is reset and therefore issues a remote stop. A new starting procedure is then initiated and the same happens again. This procedure will repeat continuously.

Because there is a delay in the time taken by the GCP/AMG to detect an interface error (i.e. the error must be present for several seconds before the GCP/AMG is triggered), the fact that the GW 4 Gateway was momentarily reset is not detected as an error.

GW4/232



Functional Overview

The following protocols are implemented in this GW 4 (interface converter from CAN bus to RS-232 interface):

- Modbus RTU slave (only two participants are possible) **GW 4/232/MOD**
- Leonhard data protocol **GW 4/232/LDP**

The following functions are supported with this:

- Remote monitoring: display of all measured values
- Remote control: data transmission

GW 4/232/MOD [Modbus RTU Slave]

Interface Data

Data	Character length	8 bit
	Stop bit	1 bit
	Parity bit	no parity
	Data format	16 bit binary values
	Transmission rates	1,200 / 2,400 / 4,800 / 9,600 / 19,200 / 38,400 Bauds
	Procedure	Modbus RTU Slave

A maximum of 20 words can be read or 10 words can be written with one command. Modbus function codes 03, 04, 06 and 16 are supported.



NOTE

Only two participants (1 Master and 1 Slave) can be connected for Modbus with interface RS-232.

Remote Monitoring (Measured Value Display)

Refer to Appendix C on page 41 for data word assignment.



NOTE

Bit 15 in the addresses 0, 70, ... (always first address of the data block) is set, if the GW 4 receives data from the CAN bus. (It may be used for CAN interface monitoring).

Remote Control (Sending Set Point Values/Control Commands)

Three words are sent cyclically from the GW 4 Gateway to each unit connected that can be controlled remotely. These usually comprise:

- Set point power
- Set point power factor
- Word containing control bits

The relevant words must be sent to the corresponding data blocks for transmission. Refer to Appendix C on page 41 for data word assignment.

The meaning of the data depends on the lower-level unit and is contained in the manual of this unit.

GW 4/232/LDP [Leonhard Data Protocol]

The Leonhard Data Protocol is an ASCII protocol for connecting to a PC via a serial port. It allows remote control (transmission of set point values/control commands), remote monitoring (visualization of measured data), and remote configuration (modification of unit parameters). This protocol is normally only used by the LeoPC1 program. Details about this protocol are available upon request.

The baud rate of this communications link can be configured to 38,400 or 9,600 Bauds. Please note that you have to configure the same baud rate in LeoPC1.



NOTE

The GW 4/232/LDP may be operated with a modem, which does not require external configuration. We recommend the following modems:

- **Analog connection: Phoenix PSI-Data/Fax-Modem/RS232**
- **GSM connection: INSYS GSM 4.0**

It is possible for both, to dispatch a fax or a short message by the means of a discrete input.

GW 4/485



Functional Overview

The following protocols are implemented in this GW 4 (interface converter from CAN bus to RS-485 interface):

- Modbus RTU slave **GW 4/485/MOD**

The following functions are supported with this:

- Remote monitoring: display of all measured values
- Remote control: data transmission

GW 4/485/MOD [Modbus RTU Slave]

Interface Data

Data	Character length	8 bit
	Stop bit	1 bit
	Parity bit	no parity
	Data format	16 bit binary values
	Transmission rates	1,200 / 2,400 / 4,800 / 9,600 / 19,200 / 38,400 Bauds
	Procedure	Modbus RTU Slave

A maximum of 20 words can be read or 10 words can be written with one command. Modbus function codes 03, 04, 06 and 16 are supported.

Remote Monitoring (Measured Value Display)

Refer to Appendix C on page 41 for data word assignment.



HINWEIS

Bit 15 in the addresses 0, 70, ... (always first address of the data block) is set, if the GW 4 receives data from the CAN bus. (It may be used for CAN interface monitoring).

Remote Control (Sending Set Point Values/Control Commands)

Three words are sent cyclically from the GW 4 Gateway to each unit connected that can be controlled remotely. These usually comprise:

- Set point power
- Set point power factor
- Word containing control bits

The relevant words must be sent to the corresponding data blocks for transmission. Refer to Appendix C on page 41 for data word assignment.

The meaning of the data depends on the lower-level unit and is contained in the manual of this unit.

GW 4/232/LDP/MDM02



Functional Overview

The following functions are possible with the GW 4/232/LDP/MDM02 (interface converter from CAN bus to an external modem):

- Remote monitoring: display of all measured values via LeoPC1
- Remote control: data transmission via LeoPC1

The device forms the interface between the CAN bus used internally at Woodward and an external modem of the type

- US Robotics Courier V Everything 56k SER von 3COM.

For this, the modem has to be connected as described under Coupling via GW 4/232/LDP/MDM02 on page 33. It converts the data into an ASCII protocol (Leonhard standard protocol) which is used by the PC to write parameters and perform remote monitoring.

The DIP switches of the modems should be configured as follows:

DIP	Setting	Meaning
1	ON	Ignore DTR
2	OFF	Replies as text
3	ON	Activate replies
4	OFF	Activate echo for offline operation
5	OFF	Activate automatic call acceptance
6	OFF	Normal carrier detection
7	OFF	Display reply in all modes
8	ON	Activate AT commands
9	OFF	Terminate connection with escape code (+++)
10	ON	Load &F0 configuration from ROM



NOTE

The GW 4/232/LDP/MDM02 is especially designed to control the US Robotics modem.

Active calling is not possible. However, if this function is necessary, refer to the note under GW 4/232/LDP [Leonhard Data Protocol] on page 16. The GW 4/232/LDP/MDM02 may be used like a GW 4/232/LDP, but the different wiring and the fixed baud rate of 4,800 Baud must be considered.

GW 4/PRO



Functional Overview

The following functions are possible with the GW 4/PRO (interface converter from CAN bus to Profibus DP Slave):

- Remote monitoring: display of all measured values
- Remote control: data transmission
- Remote configuration: changing non-volatile parameters (on request)

Remote Monitoring (Measured Value Display)

The GW 4 can transfer more data than the Profibus DP can simultaneously make available. For this reason, the data is sent in packets from 0 to 7, each packet containing the data of one data block. Thus, packet 0 contains the data of data block 1, packet 1 the data of data block 2, etc. In order to receive the data of a packet from GW 4, the corresponding packet number (packet pre-selection) is transmitted from the higher-level controller. After receiving the packet, GW 4 sends an echo to the higher-level controller to acknowledge the successful transmission (echo packet pre-selection). This echo will be sent twice in two different bytes. Only if both echo bytes contain the same value, the received data block (70 words) is valid. The addresses of the received data are described under Parameter on page 21. The meaning of the data depends on the lower-level unit and is contained in the manual of this unit.

Remote Control (Sending Set Point Values/Control Commands)

Three words are sent cyclically from the GW 4 Gateway to each unit connected that can be controlled remotely. These usually comprise:

- Set point power
- Set point power factor
- Word containing control bits

The relevant send commands of the Profibus DP transmission range must be written for transmission. The addresses of the transmission data are described in the following under Parameter on page 21. The meaning of the data depends on the lower-level unit and is contained in the manual of this unit.

Remote Configuration (Changing Non-Volatile Parameters)



NOTE

Improper configuration may result a damage of the system. A special training by Woodward personnel is required for remote configuration.

The following sequence is necessary for reading and writing the parameters (the addresses of the receiving and transmission data are described in the following under Parameter on page 21):

- 1.) A remote configuration can only be started if the status of the remote configuration is "zero". If this is not the case, the command "Remote configuration" must be set to "zero", until this status is reached.
- 2.) The ID of the value to be configured is written to "ID remote configuration".
- 3.) If a value is to be written, this value has to be written to "Data remote configuration".
- 4.) The number of the unit to be configured [1 to 8] has to be written to the second byte of "Command remote configuration".
- 5.) If parameters are to be read, 255d (0xFFh) will be written to the first byte of " Command remote configuration ", and for the case that values are to be written, 238d (0xEEh) will be written to this byte.
- 6.) There is a delay until bit 2 is set in "Status remote configuration" of approximately 500 ms).
- 7.) If bit 0 in "Status remote configuration " is set, a failure has been detected. As a result, the complete sequence has to be repeated beginning with 1.
- 8.) If a value is to be read, this value is contained in "Echo data". The sequence is finished consequently.
- 9.) If a value has been written, the written value has to be read for checking it (as described above).

The assignment "ID ↔ Configuration value" differs for each unit to be configured and can be delivered on request.

Notes

The data is organized word-by-word with leading high byte.

- | | |
|-------------------------------|--|
| Receive test byte | The receive test byte can be used to check the connection between higher-level controller (Profibus Master) and GW 4, bit 0 of which is changing every 2,5 seconds. |
| Transmission test byte | Bit 0 may be used as test bit for the GW 4. If watchdog monitoring is enabled using the configuration screens, the master has to change this bit at least every 4 seconds. GW 4 monitors this inversion and re-initializes the interface if this is not the case. Monitoring can be disabled using the configuration screens without affecting the function. |
| GSD file | The GSD file on the enclosed floppy disc is to be used. The GSD file may also be downloaded on the GW 4 product page of the Woodward website. |



NOTE

It must be observed that the Profibus connection of the PLC requires a Master, which has at least 200 Bytes consistency range. PLCs with lower consistency range do not work.

Parameter

Data received by the Profibus Master:

Bytes 0 through 7	Echo remote configuration
Byte 0/1	Echo command
Byte 2/3	Echo ID
Byte 4/5	Echo data
Byte 6/7	Status of remote configuration
Bit 0 = 1 ..	Error in the remote configuration
Bit 1 = 1 ..	Command "Remote configuration" is currently being processed
Bit 2 = 1 ..	Com. "Remote configuration" has been successfully completed
Byte 8 ^{#1}	
Bit 8	is set, if the GW 4 receives data from the CAN bus (it may be used for CAN bus monitoring)
Byte 9 ^{#1}	Echo packet pre-selection [0 to 7]
	Only if both echoes (bytes 9 + 184) are identical to the pre-selection, the data is valid
Bytes 10 to 147	Measured data of the selected generator [69 words]
	See "Transmission telegram" in the corresponding manual of the unit (e.g. GCP-30)
Byte 184	Echo packet pre-selection [0 to 7]
	Only if both echoes (bytes 9 + 184) are identical to the pre-selection, the data is valid
Byte 185	Receive test byte

Data sent by the Profibus Master:

Byte 0	Packet pre-selection [0 to 7]
	0 = Generator 1, 1 = Generator 2, etc.
Byte 1	Transmission test byte
Bit 0	Watchdog bit
	(If watchdog monitoring is set to "ON" in the configuration screen, this bit must be inverted every 4 seconds. GW 4 monitors this and, if necessary, re-initializes the interface.)
Byte 8 through 15	Remote configuration commands ^{#2}
Byte 8/9	Command remote configuration
Byte 10/11	ID remote configuration
Byte 12/13	Date remote configuration
Byte 14/15	Open
Byte 16 to 63	Remote control data
Byte 16/17	1. Control word (e.g. set point power), Generator 1
Byte 18/19	2. Control word (e.g. set point power factor), Generator 1
Byte 20/21	3. Control word (e.g. control bits), Generator 1
...	
Byte 22/23	1. Control word (e.g. set point power), Generator 2
Byte 24/25	2. Control word (e.g. set point power factor), Generator 2
Byte 26/27	3. Control word (e.g. control bits), Generator 2
...	
Byte 58/59	1. Control word (e.g. set point power), Generator 8
Byte 60/61	2. Control word (e.g. set point power factor), Generator 8
Byte 62/63	3. Control word (e.g. control bits), Generator 8

^{#1} For the expanded Block: Byte 8 and Byte 9 contain the first data word. See Page 41.

^{#2} Bytes 8 to 15 must be set to zero "0" if this is not configured.

Machine Bus Monitoring For GW 4/xxx/MOD



The Modbus (terminals Y1/Y5) is monitored with regard to its function. If a function is no longer detected, a fault message is issued on the guidance bus (terminals X1/X5).

Meaning of the bits in control word 3 of the telegram "Remote control via Gateway GW 4" of the GCP:

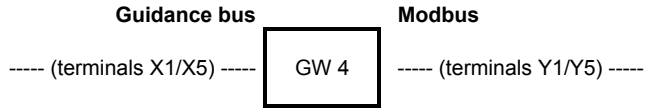

Bit	Meaning		
Bit 15	passed through from Modbus		
Bit 14	passed through from Modbus		
Bit 13	passed through from Modbus		
Bit 12	passed through from Modbus		
Bit 11	passed through from Modbus		
Bit 10	passed through from Modbus		
Bit 9	passed through from Modbus		
Bit 8	passed through from Modbus		
Bit 7	passed through from Modbus		
Bit 6	passed through from Modbus		
Bit 5	passed through from Modbus		
Bit 4	passed through from Modbus		
Bit 3	always 0		
Bit 2	for Y bus monitoring - 0 if Y bus OK - 1 if Y bus not OK - otherwise always 0		Y bus bit If Modbus monitoring can be switched on/off via remote configuration, this bit is evaluated by GW 4 thereupon. - 0 Monitoring ON - 1 Monitoring OFF
Bit 1	passed through from Y bus		
Bit 0	passed through from Y bus		



NOTE

In order to stop Y bus monitoring, only the respective bit has to be set to 1 for one generator.



NOTE

In case of the data word 2, power factor (cosphi), it is possible to set bits 8 through 15 to 0 with the parameter "Delete Hi-Byte Word 2".

This may be used to indicate that the CAN connection is still active to some devices.

Chapter 6.

Display and Control Elements

Front Panel



The touch-sensitive front panel has a plastic coating. All keys have been designed as touch-sensitive membrane keys. The Liquid Crystal display displays 2×16 characters that are indirectly illuminated in green. The contrast of the display can be infinitely adjusted with a rotary potentiometer positioned on the left.

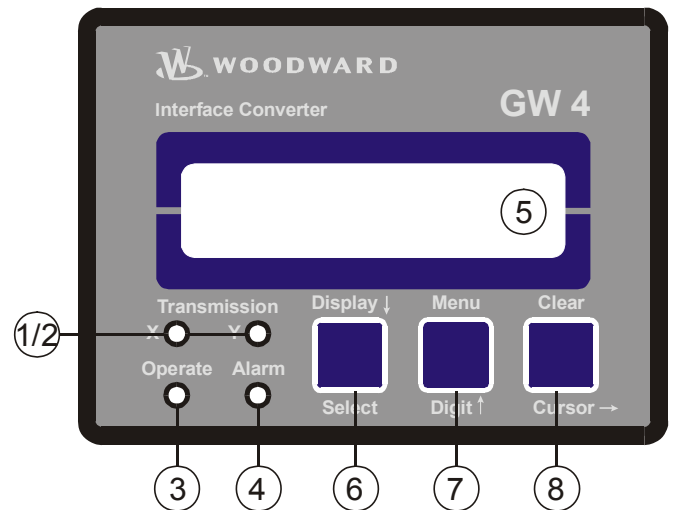

Figure 6-1: Front panel

LEDs:

- | | | |
|---|-----------|-----------------------------------|
| ① | "X" | Data communication on X terminals |
| ② | "Y" | Data communication on Y terminals |
| ③ | "Operate" | Automatic mode |
| ④ | "Alarm" | Alarm present |

LC Display:

- | | | |
|---|--------------|------------|
| ⑤ | "LC Display" | LC Display |
|---|--------------|------------|

Push Buttons:

- | | | |
|---|---------------------|--------------------------------------|
| ⑥ | "Display↓ / select" | Confirm selection and scroll display |
| ⑦ | "Digit↑" | Increment digit |
| ⑧ | "Cursor→" | Move cursor position to the right |

LEDs



- ① **LED "X"** **Data communication on X terminals** **Color "YELLOW"**

This LED is flashing, if data is received on the CAN bus (guidance bus).
- ② **LED "Y"** **Data communication on Y terminals** **Color "YELLOW"**

on The LED is on for an outgoing connection [GW 4/MDM] if data is transferred.
flashing ... The LED is flashing if for the [GW 4/...
 .../MDM02] data is sent
 .../xxx/LDP] data is sent
 .../xxx/MOD] data is received
 .../xxx/3964] data is received
 .../PRO] a connection to the Profibus Master is established
- ③ **LED "Operate"** **Operation** **Color "GREEN"**

This LED is on if the unit is in automatic mode. If it is in configuration mode, this LED is flashing.
- ④ **LED "Alarm"** **Alarm** **Color "RED"**

The alarm LED is not used for the GW 4 at the moment.

LC Display



- ⑤ **ANZEIGE "LC Display"** **LC Display**

The two-line liquid crystal display displays the respective messages and values depending on the selected mode. The parameters are changed in configuration mode.

Automatic Mode (First Display Line)

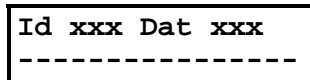

Display in automatic mode, first line

Id xxx Send address
Dat xxx Sent value or 0

Automatic Mode (Second Display Line)

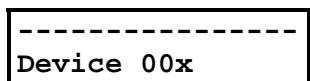

Display in automatic mode, second line

The number of the device, to which remote control data has been sent before.

only Modbus/PRO

Push Buttons



In order to facilitate the parameter setting, the buttons have an AUTOROLL function. It allows to switch to the next setting and configuration screens, digits, or cursor positions. The AUTOROLL function becomes active if the user holds the respective key pressed down for a certain time.

- | | | |
|---|---|---|
| ⑥ | Button
"Display↓"
"Select" | Display↓ / Select |
| | | <p>Display↓.....Jump to the next configuration screen.</p> <p>SelectIf the initially displayed value has been changed with the "Digit↑" ⑦ or "Cursor→" ⑧ buttons, it will be stored by pushing the "Select" button ⑥ once. Pushing the "Select" button ⑥ again makes the display jump to the next configuration screen.</p> |
| ⑦ | Button
"Menu"
"Digit↑" | Menu / Digit↑ |
| | | <p>MenuThis function is not used at the moment.</p> <p>Digit↑.....This button increases the digit at the cursor position. It will only be increased within the configurable limits according to the parameter list in the appendix. If the highest number has been reached, the digit jumps to the smallest possible value automatically.</p> |
| ⑧ | Button
"Clear"
"Cursor→" | Clear / Cursor→ |
| | | <p>Clear.....This function is not used at the moment.</p> <p>Cursor→.....This button moves the cursor one position to the right. If the right-most position has been reached, the cursor jumps to the first digit at the left of the value to be entered.</p> |

Chapter 7. Configuration



You get into configuration mode by pressing the "Digit↑" (7) and "Cursor→" (8) buttons simultaneously. You can scroll through the single configuration screens with the "Display↓" (6) button in configuration mode. Pressing the "Display↓" (6) button and keeping it pressed activates the AUTOROLL function to enable quicker scrolling through the screens. Please note that it is not possible to scroll backwards. If no entry, change or any other action has been performed for a period of 60 seconds, the unit returns to automatic mode automatically.

General Configuration Screens



Software version
XXXXXXXXXXXXXXXXXXXX

Version number **Info**

Display of the software version (xxx stands for modifications, which have no effect on the functionality of the unit). Later versions have 4 decimals. Moreover, the interface type on the Y terminals (e.g. modem) is displayed here.

	Display
	XXXXXXXXXXXXXXXXXXXX
GW 4/MDM02	Vx .xxx Modem
GW 4/xxx/LPD	Vx .xxx LPD
GW4/xxx/MOD	Vx .xxx Modbus
GW4/PRO	Vx .xxx Profibus

SPRACHE / LANGUAGE

Language selection **German/English**

The screens (configuration and display screens) can either be displayed in German or English.

Remote control m
at 00s

Send remote message every **1 to 20 s**

Time in seconds until all connected devices have received a complete remote configuration message (only MOD, PRO).

Transmit-ID
 000

Transmission code ID **830/831**

Using this screen, you can switch the Transmit ID of the GW 4 between 830 and 831 for later extensions. The default value is 831.

Baudrate

Baud rate **see Chapter 5 "Function"**

Baud rate selection.

*only GW 4/xxx/MOD
only GW 4/xxx/LDP*

Parity -----

only GW 4/xxx/MOD

Protocol Type	0
---------------	---

only GW 4/xxx/LDP

PROFIBUS station	000
------------------	-----

only GW 4/PRO

PROFIBUS watch-dog	OFF
--------------------	-----

only GW 4/PRO

Slave-No.	00
-----------	----

only GW 4/xxx/MOD

Stopbits -----

only GW 4/xxx/MOD

Delay to send Modbus	00,0ms
----------------------	--------

only GW 4/xxx/MOD

Timeout Y-Bus monitoring	NO
--------------------------	----

only GW 4/xxx/MOD

Timeout Y-Bus switchable	NO
--------------------------	----

only GW 4/xxx/MOD
Y bus monitoring ON

Parity **none / even / odd**

Parity selection.

Protocol type **1/2/3**

Used to be able to evaluate extended command sets of later versions of LeoPC1. The default value is 1.

- 1 LeoPC1 standard protocol
- 2 LeoPC1 extended standard protocol
- 3 LeoPC1 extended standard protocol for easYgen

Station name of the Profibus **0 to 126**

The station number of the Profibus DP is entered here.

Watchdog functions **ON/OFF**

- ON**..... The watchdog bit is monitored additionally according to the above description.
- OFF** Monitoring of the watchdog it is disabled. A Profibus transmission is still possible.

Slave number **1 to 99**

Enter the slave number of the Modbus here.

Number of stop bits **one/two**

Determine the number of stopbits here.

Delay to send Modbus **0.2 to 50.0 ms**

Configuration of the waiting time between the reception of the message by the GW 4 and the answer by the GW 4. This time is required to give the PLC enough time to switch the Modbus back to high resistance. If this time is too short, transmission failures may occur (default setting is 3 ms at 9,600 bauds; other baud rates may require accordingly less time).

Y bus monitoring **YES/NO**

- YES** Monitoring of the Y bus is enabled
- NO** Y bus is not monitored

Y bus monitoring can be enabled externally **YES/NO**

- Yes**..... Y bus (Modbus) monitoring by the GW 4 can be enabled or disabled using the Y bus. The Y bus bit is used as control bit.
- NO**..... Y bus (Modbus) monitoring is enabled.

Timeout Y-Bus
max. delay 000s

only GW 4/xxx/MOD
Y bus monitoring ON

Y bus monitoring maximum time 0 to 999 s

Maximum time without data transmission before a Y bus (Modbus) failure is issued.

receiver only
YES

Receiver only type YES/NO

Note: If several GW 4s are connected to one CAN bus, this parameter may only be set to "NO" for maximum one GW 4.

YESAll CAN write operations of the GW 4 to the controlled unit are blocked. It is only possible to read measurement data (only remote monitoring, no remote control, no remote configuration).

NOThe GW 4 can read data as well as write data (default).

Parameterize
time out 0,0s

only GW 4/xxx/MOD

Timeout for configuration 0.1 to 9.9 s

The timeout is used to adapt to different configurations of the unit. It should be configured to 2.0 s.

Data Transmission Mode



Delete Hi-Byte
Word 2 YES

only GW 4/xxx/MOD

Delete Hi-Byte word 2 YES/NO

This configuration screen is available for future functions. It has to be configured to "YES" by default.

NOThe data of the data word 2, cosphi, of the remote control data will be transmitted without modification.

YESBit 8 to 15 (Hi-Byte) of the data word 2 of the remote control data will be set to "0".

change CAN-IDs
NEIN

Change receive ID YES/NO

If this parameter is configured to "YES", the receive ID of the GW 4 on the CAN bus can be changed using the following screen. If this parameter is configured to "NO", the standard value "801" is enabled.

Block X receive
of CAN-ID 000

x = 1 to 8

Set receive ID 0 to 2047

This screen enables to switch the receive ID of the GW 4 on the CAN bus per block between 801 and 808 for future extensions. For this is valid: block 1 = ID 801, block 2 = ID 802, ..., block 8 = ID 808. Ensure that no two blocks have identical IDs. This setting does not change the settings of the second interface.

Configuration Expansion (Sub-Units)



`expand block x`
`NEIN`

x = 1/3/5/7

Expand block x

YES/NO

Two consecutive blocks are combined (refer to Appendix C).



NOTE

Further information about this can be found in the appendix under Size of the Receive Blocks on page 36.

Chapter 8. Technical Data

Ambient variables -----	
- Power supply (V_{aux})	24 Vdc (18 to 30 Vdc)
- Intrinsic consumption.....	max. 10 W
- Ambient temperature.....	-20 to +70 °C
- Ambient humidity	95 %, not condensing
Interface -----	
CAN bus interface	galvanically isolated
- Isolation voltage.....	1,500 Vdc
- Version.....	CAN bus
- Internal line termination.....	n/a
RS-232 interface (Models GW 4/232 and GW 4/232/LDP/MDM02)	
- Version.....	RS-232 Standard
RS-485 interface (Model GW 4/485)	
- Version.....	RS-485 Standard
Profibus interface (Model GW 4/PRO)	
- Version.....	Profibus DP Slave Standard
Housing -----	
- Type	APRANORM DIN 43 700
- Dimensions (W × H × D).....	96 × 72 × 130 mm
- Front panel cutout (W×H).....	91 [+1,0] × 67 [+0,7] mm
- Wiring	Screw-type terminals depending on plug connector 1,5 mm ² or 2,5 mm ²
-	use 60/75 °C copper wire only
-	use class 1 wire only or equivalent
- Weight.....	depending on version, approx. 800 g
Protection -----	
- Protection class	IP21, from front IP45
- Front foil	insulating surface
- EMV test (CE)	tested according to applicable EN guidelines
- Listings.....	CE marking

Chapter 9. Data Connection

Coupling via GW 4/232



Data coupling Coupling via GW 4/232

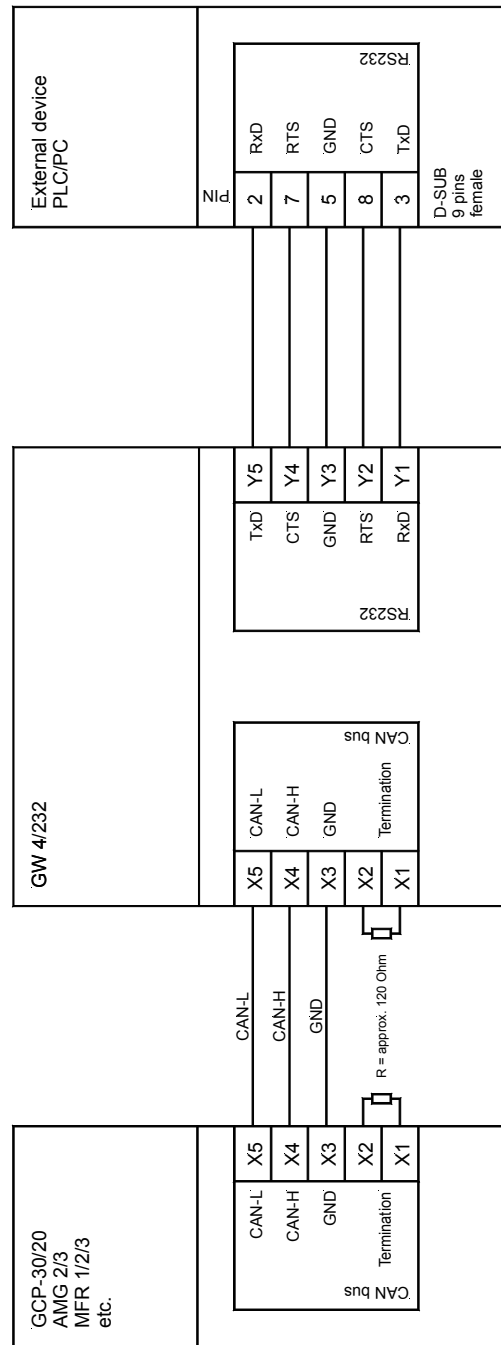

2003-01-24 | Datenkopplung 2003-01-24.skr

Figure 9-1: Data coupling - GW4/232



Data coupling Coupling via GW 4/485



Coupling via GW 4/485

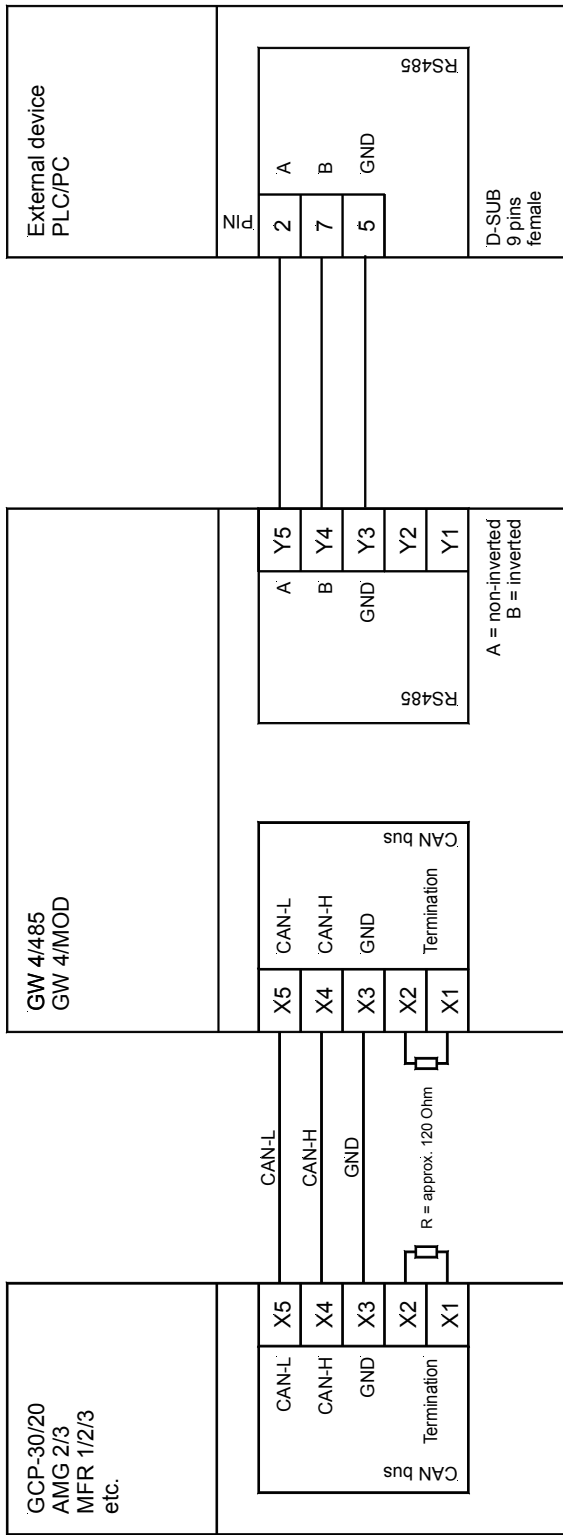

2003-01-24 | Datenkopplung 2003-01-24.skf

Figure 9-2: Data coupling - GW4/485

Coupling via GW 4/232/LDP/MDM02



Data coupling

Coupling via GW 4/MDM02 (modem)

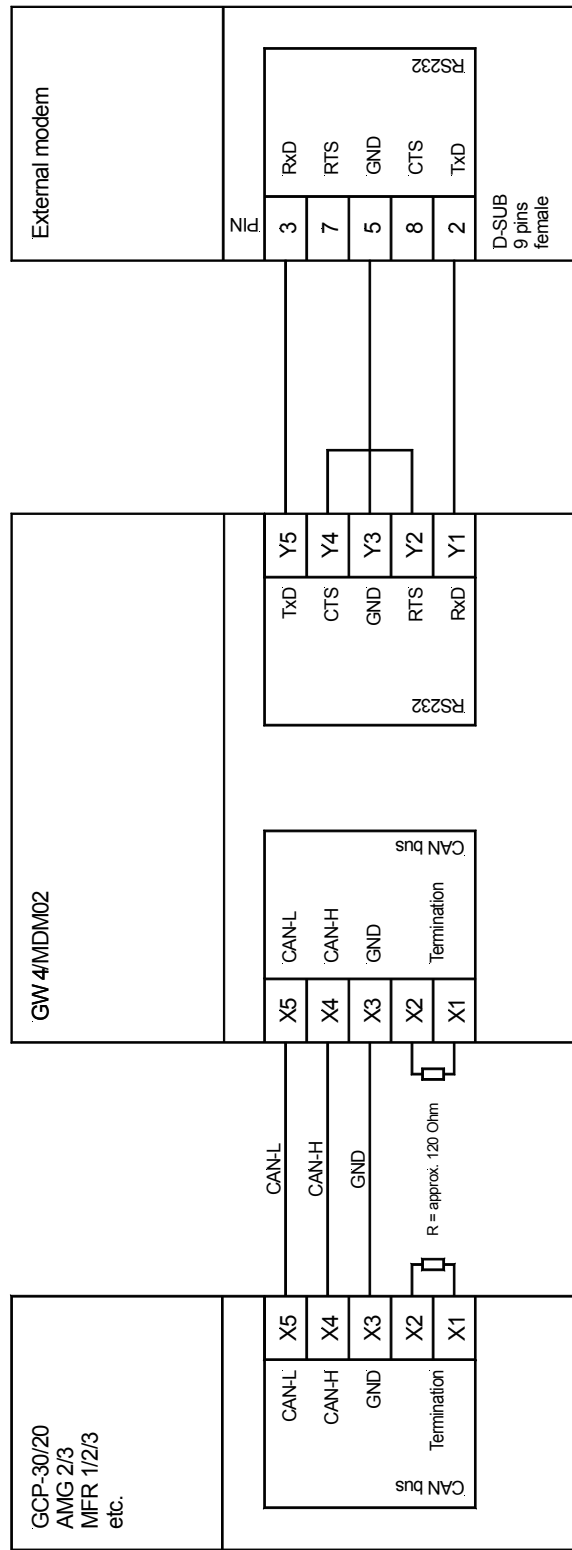

2003-01-24 | Datenkopplung 2003-01-24.skf

Figure 9-3: Data coupling - GW4/MDM02



Data coupling Coupling via GW 4/PRO (Profibus DP)

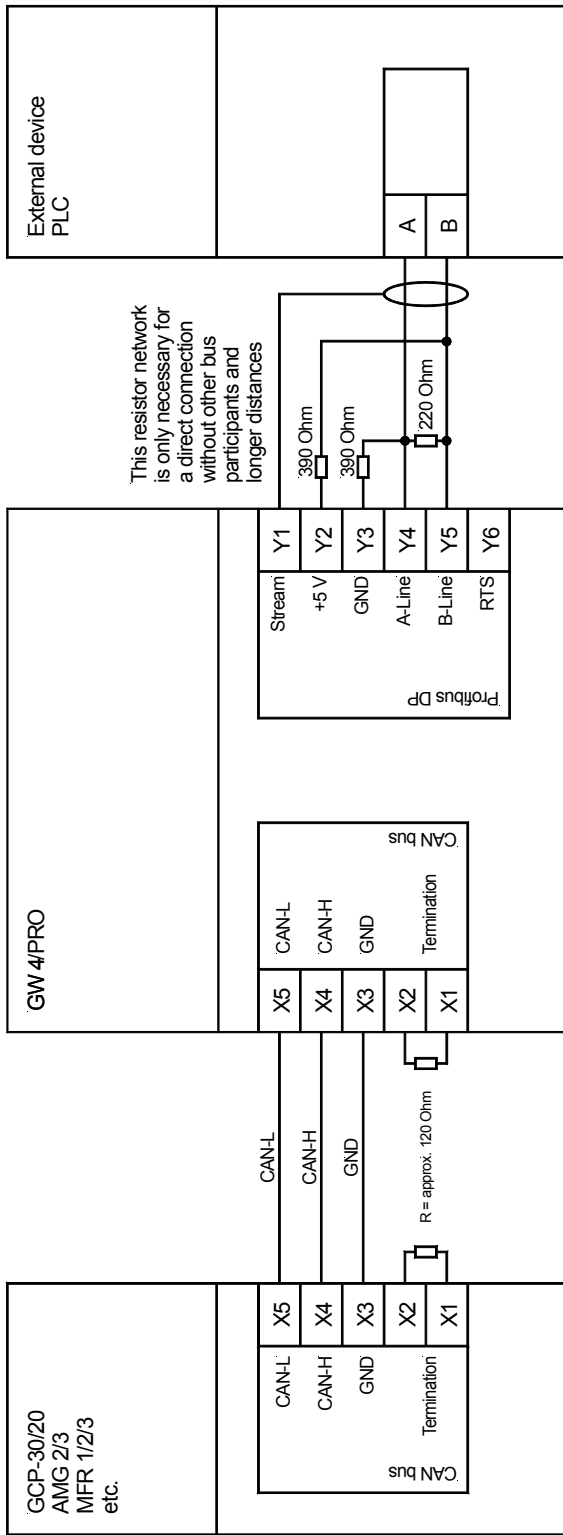

2003-01-24 | Datenkopplung 2004-08-30.skf

Figure 9-4: Data coupling - GW4/PRO

Appendix A. Practical Applications

Structure of the GW 4



The GW 4 transmits data from a bus to the CAN bus.

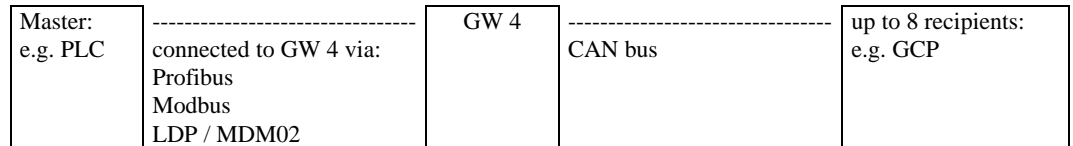

The CAN Interface



General Information

Up to 8 units can be connected to the GW 4 using the CAN bus.
 The baud rate of the CAN bus is 125kBaud and cannot be configured.
 The GW 4 receives only CAN messages in the formats
 DD <Mux> <data word 1> <data word 2> <data word 3>; Mux from 0 to DC Hex
 or
 <Mux> DD <data word 1> <data word 2> <data word 3>; Mux from 1 to DC Hex.
 The last format is outdated and shall not be supported in future.

Settings for Receiving CAN Messages

The GW 4 receives by default on the following CAN IDs:

CAN ID	Block No.
801	Block 1
802	Block 2
803	Block 3
804	Block 4
805	Block 5
806	Block 6
807	Block 7
808	Block 8

These blocks can be changed using the parameter: "Block x receive on CAN-ID xxxx".
 If the GW 4 receives data, the "X" LED is flashing.

Size of the Receive Blocks

A block may receive a maximum of 138 bytes. This is enough for most units. The parameter "expand block x" allows to unite two blocks to one. 276 bytes can be received then. However, the subsequent block cannot receive data anymore then.

Block 1 expanded	Receives data on CAN ID of block 1
Block 2	Receives no data; data on CAN ID is ignored
Block 3 not expanded	Receives data on CAN ID of block 3
Block 4	Receives data on CAN ID of block 4
Block 5 expanded	Receives data on CAN ID of block 5
Block 6	Receives no data; data on CAN ID is ignored
Block 7 expanded	Receives data on CAN ID of block 7
Block 8	Receives no data; data on CAN ID is ignored

Reading out data from an expanded block is performed like for two not expanded blocks.

Please note:

Modbus: Data word 0 of the block following the expanded block corresponds with data word 70 of the connected device.

Profibus: One package may contain one block. This means that the PLC has to read the packages 0 and 1 for expanded blocks.

Notes to expanded blocks:

If a block is expanded, the data for the following block is ignored. But no CAN IDs should still be configured identically.

Sending CAN Messages

CAN messages can be sent via the GW 4.

These are remote control and configuration messages coming from the master.

Sending a message from the GW 4 is performed on CAN ID 830 or 831. The CAN ID is configured using the parameter "Transmit-ID".

If a receiver is connected to the GW 4 (GW 4 receives data), the GW 4 transmits remote control messages.

Remote control messages are only transmitted for connected units.

A remote control message consists of 3 CAN messages.

This is performed once for each recipient every 3 seconds.

With this, 24 CAN messages are sent every 3 seconds for 8 recipients.

For 1 recipient, only 3 CAN messages are sent in 3 seconds.

Depending on the connected receiver, it may be necessary to transmit the remote control messages faster or slower. This is performed using the parameter "Remote control m. at xxs".

If 10 seconds is entered here, 24 CAN messages will be sent every 10 seconds for 8 recipients, or only 3 CAN messages for one recipient.

If the GW 4 shall not send CAN messages, the parameter "receiver only" must be configured YES.

Notes to expanded blocks:

Fixed device numbers are assigned to the blocks:

Block No.	1	2	3	4	5	6	7	8
Device No.	1	2	3	4	5	6	7	8

A remote control message will only be sent to a device no., which is recognized as active. If a block is configured to 'extended', the following device will not be detected as active.

If block 1 is configured as 'extended' for example, the device with the generator no. 2 will not be detected as active, even if visualization data is received on block 3.

In order to avoid this problem, one or more GW 4 may be used to receive the visualization data, and another to send the remote control data.

**NOTE**

If several GW 4s are connected to one CAN bus, the Transmit ID must be configured differently, or the GW 4 must be configured in a way that it does not send CAN messages (see above).

The Profibus Interface



The GW 4 may be equipped with a Profibus DP slave interface. It is used to connect to a PLC.

The baud rate of the Profibus interface is predetermined by the master.

The Profibus station has to be configured at the GW 4 using the parameter "PROFIBUS station".

A data volume of 186 bytes is transmitted on the Profibus. The meaning of each byte can be found under Parameter on page 21.

The general sequence is as follows:

1. Write the number of the desired block into byte 0 "Packet preselection" of the data sent by the Profibus Master.
2. Wait until this number re-appears in both bytes (9 & 184) "Echo packet preselection" (the received data block is only valid if the same values is contained in both bytes). The data of the selected block is transmitted.
3. Check, whether bit 8 is set in byte 8 "CAN watchdog". If yes, CAN data is also received on this block.
4. The data on byte 10 to 147 can be evaluated. (See description of the unit, which is received by the GW 4 on this block.)

Modbus



The Modbus protocol can be used with an RS-232 or an RS-485 interface hardware.

The GW 4 operates as Modbus slave.

Baud rate, parity and number of stop bits are to be configured at the GW 4 like for the remote terminal.

The slave number is the number, which is used by the Modbus master to address the GW 4.

The parameter "Delay to send Modbus" is used to configure a minimum time between receiving a message and the reply of the GW 4s. This is important to give the master enough time to release the line for the reply if the GW 4 is connected to the master via an RS-485 interface.

Modbus Monitoring

A unit connected to the GW 4 can detect with Modbus monitoring, whether the Modbus master is still active or not.

This serves for validating the transmission of remote control data.

The parameter "Timeout Y-Bus monitoring" must be configured YES for this.

The parameter "Timeout Y-Bus max. delay" is used to configure the minimum time, for which the Modbus has to fail, before an alarm is issued.



NOTE

If no remote control data is sent by the master, but only visualization data is read out, the Modbus is considered as OK. No failure is reported to the connected units.

The parameter "Timeout Y-Bus switchable" is used to determine whether the Modbus monitoring can be enabled or disabled by the master or not.

Sending Data

Data, which is sent to the GW 4, can not be read out.

The parameter "Delete Hi-Byte Word 2" is used to determine whether the High byte of the control word for the set point power factor transmission is always set to 0. Some units have to rely on this because they use this to check whether correct data is sent on the CAN bus.

LDP Protocol



The parameter "Baudrate" must be configured the same in LeoPC1 and in the GW 4. Apart from that, the GW 4 has the following data: no parity, 8 data bits and 1 stop bit.

The parameter "Protocol Type" must be configured 2 if the extended standard protocol is used in LeoPC1.

Modem



The LDP protocol is used for the GW 4/MDM02. The GW 4/MDM02 can be connected directly to a PC like a GW 4/LDP.

When wiring the unit, ensure that Y2 and Y4 are jumpered. The baud rate must be configured to 4,800 bauds in LeoPC1.

Several GW4s at one CAN Bus



It is principally possible to connect several GW 4s to one CAN bus.

But the following has to be noted for this:

The Transmit ID of the GW 4s must not be the same. The parameter "receiver only" is configured YES for this – no data is transmitted.

Now, remote control/configuration is possible with a GW 4.

Appendix B. Application Restrictions

Only one GW 4 may send at one time on the CAN bus (Parameter "receiver only" = NO).

The GW 4 is only able to remote control units, which are assigned to the device numbers 1 to 8.

70 data words = no extended block (standard)

more than 70 data words = extended block (e.g. easYgen-1500, GCP-30 with SB03 or SC06, SC07, SC08)

Number of devices	Application	Required GW 4s	Comments
8 devices with 70 data words	Visualization and remote control	1 GW 4	Device no. 1 is to be assigned to receive box no. 1 and so on.
1 device with extended block	Visualization and remote control	1 GW 4	Device is to be assigned to receive box no. 1.
2 to 4 devices with extended block	Visualization	1 GW 4	Devices may be assigned to any receive boxes.
2 to 4 devices with extended block	Visualization and remote control	2 GW 4	The first GW 4 is responsible for the transmission of the visualization data only (only receiver). The second GW 4 is responsible for remote control only (no extended blocks, Device no. 1 is to be assigned to receive box no. 1 and so on).
5 to 8 devices with extended block	Visualization	2 GW 4	Devices may be assigned to any receive boxes.
5 to 8 devices with extended block	Visualization and remote control	3 GW 4	The first and second GW 4 is responsible for the transmission of the visualization data only (only receiver). The third GW 4 is responsible for remote control only (no extended blocks, Device no. 1 is to be assigned to receive box no. 1 and so on).
More than 8 devices with 70 data words	Visualization	One GW 4 is required per 8 devices	Devices may be assigned to any receive boxes. Remote control is not possible.
More than 8 devices with extended block	Visualization	One GW 4 is required per 4 devices	Devices may be assigned to any receive boxes. Remote control is not possible.

Exception:

5 devices with extended block	Visualization and remote control	2 GW 4	The first GW 4 is responsible for the transmission of the visualization data of the devices 1 to 4 only (only receiver). The second GW 4 is responsible for remote control of the units 1 to 5 as well as for the visualization of the 5 th device (block 3 extended, device no. 1 is assigned to receive box no. 1, device no. 2 is assigned to box no. 2 (standard)).
-------------------------------	----------------------------------	--------	---

Appendix C. Data Assignment Table

Receiving Table of the GW 4



Profibus receiving byte for packet preselection see below	Modbus address GW4	without expanded blocks	with expanded blocks
8.9	1	Bit 15 is set, if valid CAN messages are received on the CAN ID of block 1.	Bit 15 is set, if valid CAN messages are received on the CAN ID of block 1.
10.11	2	Mux 0 word 1 of the data received on the CAN ID of block 1	Mux 0 word 1 of the data received on the CAN ID of block 1
12.13	3	Mux 0 word 2 of the data received on the CAN ID of block 1	Mux 0 word 2 of the data received on the CAN ID of block 1
14.15	4	Mux 0 word 3 of the data received on the CAN ID of block 1	Mux 0 word 3 of the data received on the CAN ID of block 1
16.17	5	Mux 1 word 1 of the data received on the CAN ID of block 1	Mux 1 word 1 of the data received on the CAN ID of block 1
18.19	6	Mux 1 word 2 of the data received on the CAN ID of block 1	Mux 1 word 2 of the data received on the CAN ID of block 1
20.21	7	Mux 1 word 3 of the data received on the CAN ID of block 1	Mux 1 word 3 of the data received on the CAN ID of block 1
22.23	8	Mux 2 word 1 of the data received on the CAN ID of block 1	Mux 2 word 1 of the data received on the CAN ID of block 1
24.25	9	Mux 2 word 2 of the data received on the CAN ID of block 1	Mux 2 word 2 of the data received on the CAN ID of block 1
...	10	Mux 2 word 3 of the data received on the CAN ID of block 1	Mux 2 word 3 of the data received on the CAN ID of block 1
Packet 0 / Gen 1
...	62	Mux 20 word 1 of the data received on the CAN ID of block 1	Mux 20 word 1 of the data received on the CAN ID of block 1
132.133	63	Mux 20 word 2 of the data received on the CAN ID of block 1	Mux 20 word 2 of the data received on the CAN ID of block 1
134.135	64	Mux 20 word 3 of the data received on the CAN ID of block 1	Mux 20 word 3 of the data received on the CAN ID of block 1
136.137	65	Mux 21 word 1 of the data received on the CAN ID of block 1	Mux 21 word 1 of the data received on the CAN ID of block 1
138.139	66	Mux 21 word 2 of the data received on the CAN ID of block 1	Mux 21 word 2 of the data received on the CAN ID of block 1
140.141	67	Mux 21 word 3 of the data received on the CAN ID of block 1	Mux 21 word 3 of the data received on the CAN ID of block 1
142.143	68	Mux 22 word 1 of the data received on the CAN ID of block 1	Mux 22 word 1 of the data received on the CAN ID of block 1
144.145	69	Mux 22 word 2 of the data received on the CAN ID of block 1	Mux 22 word 2 of the data received on the CAN ID of block 1
146.147	70	Mux 22 word 3 of the data received on the CAN ID of block 1	Mux 22 word 3 of the data received on the CAN ID of block 1
8.9	71	Bit 15 is set, if valid CAN messages are received on the CAN ID of block 2.	Mux 23 word 1 of the data received on the CAN ID of block 1
10.11	72	Mux 0 word 1 of the data received on the CAN ID of block 2	Mux 23 word 2 of the data received on the CAN ID of block 1
	73	Mux 0 word 2 of the data received on the CAN ID of block 2	Mux 23 word 3 of the data received on the CAN ID of block 1
	74	Mux 0 word 3 of the data received on the CAN ID of block 2	Mux 24 word 1 of the data received on the CAN ID of block 1
	75	Mux 1 word 1 of the data received on the CAN ID of block 2	Mux 24 word 2 of the data received on the CAN ID of block 1
	76	Mux 1 word 2 of the data received on the CAN ID of block 2	Mux 24 word 3 of the data received on the CAN ID of block 1
	77	Mux 1 word 3 of the data received on the CAN ID of block 2	Mux 25 word 1 of the data received on the CAN ID of block 1
	78	Mux 2 word 1 of the data received on the CAN ID of block 2	Mux 25 word 2 of the data received on the CAN ID of block 1
	79	Mux 2 word 2 of the data received on the CAN ID of block 2	Mux 25 word 3 of the data received on the CAN ID of block 1
	80	Mux 2 word 3 of the data received on the CAN ID of block 2	Mux 26 word 1 of the data received on the CAN ID of block 1
Packet 1 / Gen 2
	134	Mux 20 word 3 of the data received on the CAN ID of block 2	Mux 44 word 1 of the data received on the CAN ID of block 1
	135	Mux 21 word 1 of the data received on the CAN ID of block 2	Mux 44 word 2 of the data received on the CAN ID of block 1
	136	Mux 21 word 2 of the data received on the CAN ID of block 2	Mux 44 word 3 of the data received on the CAN ID of block 1
	137	Mux 21 word 3 of the data received on the CAN ID of block 2	Mux 45 word 1 of the data received on the CAN ID of block 1
	138	Mux 22 word 1 of the data received on the CAN ID of block 2	Mux 45 word 2 of the data received on the CAN ID of block 1
	139	Mux 22 word 2 of the data received on the CAN ID of block 2	Mux 45 word 3 of the data received on the CAN ID of block 1
146.147	140	Mux 22 word 3 of the data received on the CAN ID of block 2	nicht benutzt
8.9	141	Bit 15 is set, if valid CAN messages are received on the CAN ID of block 3.	Bit 15 is set, if valid CAN messages are received on the CAN ID of block 3.
10.11	142	Mux 0 word 1 of the data received on the CAN ID of block 3	Mux 0 word 1 of the data received on the CAN ID of block 3
	143	Mux 0 word 2 of the data received on the CAN ID of block 3	Mux 0 word 2 of the data received on the CAN ID of block 3
	144	Mux 0 word 3 of the data received on the CAN ID of block 3	Mux 0 word 3 of the data received on the CAN ID of block 3
	145	Mux 1 word 1 of the data received on the CAN ID of block 3	Mux 1 word 1 of the data received on the CAN ID of block 3
	146	Mux 1 word 2 of the data received on the CAN ID of block 3	Mux 1 word 2 of the data received on the CAN ID of block 3
	147	Mux 1 word 3 of the data received on the CAN ID of block 3	Mux 1 word 3 of the data received on the CAN ID of block 3
	148	Mux 2 word 1 of the data received on the CAN ID of block 3	Mux 2 word 1 of the data received on the CAN ID of block 3
	149	Mux 2 word 2 of the data received on the CAN ID of block 3	Mux 2 word 2 of the data received on the CAN ID of block 3
	150	Mux 2 word 3 of the data received on the CAN ID of block 3	Mux 2 word 3 of the data received on the CAN ID of block 3
Packet 2 / Gen 3
	202	Mux 20 word 1 of the data received on the CAN ID of block 3	Mux 20 word 1 of the data received on the CAN ID of block 3
	203	Mux 20 word 2 of the data received on the CAN ID of block 3	Mux 20 word 2 of the data received on the CAN ID of block 3
	204	Mux 20 word 3 of the data received on the CAN ID of block 3	Mux 20 word 3 of the data received on the CAN ID of block 3
	205	Mux 21 word 1 of the data received on the CAN ID of block 3	Mux 21 word 1 of the data received on the CAN ID of block 3
	206	Mux 21 word 2 of the data received on the CAN ID of block 3	Mux 21 word 2 of the data received on the CAN ID of block 3
	207	Mux 21 word 3 of the data received on the CAN ID of block 3	Mux 21 word 3 of the data received on the CAN ID of block 3
	208	Mux 22 word 1 of the data received on the CAN ID of block 3	Mux 22 word 1 of the data received on the CAN ID of block 3
	209	Mux 22 word 2 of the data received on the CAN ID of block 3	Mux 22 word 2 of the data received on the CAN ID of block 3
146.147	210	Mux 22 word 3 of the data received on the CAN ID of block 3	Mux 22 word 3 of the data received on the CAN ID of block 3
8.9	211	Bit 15 is set, if valid CAN messages are received on the CAN ID of block 4.	Mux 23 word 1 of the data received on the CAN ID of block 3
10.11	212	Mux 0 word 1 of the data received on the CAN ID of block 4	Mux 23 word 2 of the data received on the CAN ID of block 3
	213	Mux 0 word 2 of the data received on the CAN ID of block 4	Mux 23 word 3 of the data received on the CAN ID of block 3
	214	Mux 0 word 3 of the data received on the CAN ID of block 4	Mux 24 word 1 of the data received on the CAN ID of block 3
	215	Mux 1 word 1 of the data received on the CAN ID of block 4	Mux 24 word 2 of the data received on the CAN ID of block 3
	216	Mux 1 word 2 of the data received on the CAN ID of block 4	Mux 24 word 3 of the data received on the CAN ID of block 3
	217	Mux 1 word 3 of the data received on the CAN ID of block 4	Mux 25 word 1 of the data received on the CAN ID of block 3
	218	Mux 2 word 1 of the data received on the CAN ID of block 4	Mux 25 word 2 of the data received on the CAN ID of block 3

Transmission Table of the GW 4



Profibus send byte	Modbus GW4 transmits			
16.17	1	to the unit with No. 1 as set point power	if data is received	on block 1
18.19	2	to the unit with No. 1 as set point power factor	if data is received	on block 1
20.21	3	to the unit with No. 1 as control bits	if data is received	on block 1
22.23	4	to the unit with No. 2 as set point power	if data is received	on block 2
24.25	5	to the unit with No. 2 as set point power factor	if data is received	on block 2
26.27	6	to the unit with No. 2 as control bits	if data is received	on block 2
28.29	7	to the unit with No. 3 as set point power	if data is received	on block 3
30.31	8	to the unit with No. 3 as set point power factor	if data is received	on block 3
32.33	9	to the unit with No. 3 as control bits	if data is received	on block 3
34.35	10	to the unit with No. 4 as set point power	if data is received	on block 4
36.37	11	to the unit with No. 4 as set point power factor	if data is received	on block 4
38.39	12	to the unit with No. 4 as control bits	if data is received	on block 4
40.41	13	to the unit with No. 5 as set point power	if data is received	on block 5
42.43	14	to the unit with No. 5 as set point power factor	if data is received	on block 5
44.45	15	to the unit with No. 5 as control bits	if data is received	on block 5
46.47	16	to the unit with No. 6 as set point power	if data is received	on block 6
48.49	17	to the unit with No. 6 as set point power factor	if data is received	on block 6
50.51	18	to the unit with No. 6 as control bits	if data is received	on block 6
52.53	19	to the unit with No. 7 as set point power	if data is received	on block 7
54.55	20	to the unit with No. 7 as set point power factor	if data is received	on block 7
56.57	21	to the unit with No. 7 as control bits	if data is received	on block 7
58.59	22	to the unit with No. 8 as set point power	if data is received	on block 8
60.61	23	to the unit with No. 8 as set point power factor	if data is received	on block 8
62.63	24	to the unit with No. 8 as control bits	if data is received	on block 8

Appendix D. Parameter List

Device number P/N _____ Rev _____

Version _____

Project _____

Serial number S/N _____ Date _____

Opt.	Line 1	Parameter - Text -	Line 2	Setting range	Default setting	Customer settings
------	--------	-----------------------	--------	---------------	-----------------	-------------------

GENERAL CONFIGURATION						
	Sprache/Language	German/English	German	German	<input type="checkbox"/> G <input type="checkbox"/> E	<input type="checkbox"/> G <input type="checkbox"/> E
	Remote control m.	at	1 to 20 s	3		
	Transmit-ID		830/831	831		
	Baudrate		1,200 / 2,400 / 4,800 / 9,600 / 19,200 / 31,250 / 38,400 Baud	always the lowest		
	Parity		none / even / odd	none	<input type="checkbox"/> n <input type="checkbox"/> e <input type="checkbox"/> o	<input type="checkbox"/> n <input type="checkbox"/> e <input type="checkbox"/> o
	Protocol	Type	1/2	1		
	PROFIBUS station		0 to 126	0		
	PROFIBUS watch-	dog	ON/OFF	OFF	<input type="checkbox"/> ON <input type="checkbox"/> OFF	<input type="checkbox"/> ON <input type="checkbox"/> OFF
	Slave number		1 to 99	0		
	Stopbits		1/2	1	<input type="checkbox"/> 1 <input type="checkbox"/> 2	<input type="checkbox"/> 1 <input type="checkbox"/> 2
	Delay to send	Modbus	0,2 to 50,0 ms	30 ms		
	Timeout Y-Bus	monitoring	YES/NO	NO	<input type="checkbox"/> Y <input type="checkbox"/> N	<input type="checkbox"/> Y <input type="checkbox"/> N
	Timeout Y-Bus	switchable	YES/NO	NO	<input type="checkbox"/> Y <input type="checkbox"/> N	<input type="checkbox"/> Y <input type="checkbox"/> N
	Timeout-Y-Bus	max. delay	0 to 999 s	10 s		
	receiver only		YES/NO	NO	<input type="checkbox"/> Y <input type="checkbox"/> N	<input type="checkbox"/> Y <input type="checkbox"/> N
	Parameterize	time out	0,1 to 9,9 s	2		

DATA TRANSMISSION MODE						
	Delete Hi-Byte	Word 2	YES/NO	YES	<input type="checkbox"/> Y <input type="checkbox"/> N	<input type="checkbox"/> Y <input type="checkbox"/> N
	change CAN-IDs		YES/NO	NO	<input type="checkbox"/> Y <input type="checkbox"/> N	<input type="checkbox"/> Y <input type="checkbox"/> N
	Block 1 receive	of CAN-ID	0 to 2047	801		
	Block 2 receive	of CAN-ID	0 to 2047	802		
	Block 3 receive	of CAN-ID	0 to 2047	803		
	Block 4 receive	of CAN-ID	0 to 2047	804		
	Block 5 receive	of CAN-ID	0 to 2047	805		
	Block 6 receive	of CAN-ID	0 to 2047	806		
	Block 7 receive	of CAN-ID	0 to 2047	807		
	Block 8 receive	of CAN-ID	0 to 2047	808		

CONFIGURATION EXPANSION						
	expand block 1		YES/NO	NO	<input type="checkbox"/> Y <input type="checkbox"/> N	<input type="checkbox"/> Y <input type="checkbox"/> N
	expand block 3		YES/NO	NO	<input type="checkbox"/> Y <input type="checkbox"/> N	<input type="checkbox"/> Y <input type="checkbox"/> N
	expand block 5		YES/NO	NO	<input type="checkbox"/> Y <input type="checkbox"/> N	<input type="checkbox"/> Y <input type="checkbox"/> N
	expand block 7		YES/NO	NO	<input type="checkbox"/> Y <input type="checkbox"/> N	<input type="checkbox"/> Y <input type="checkbox"/> N



NOTE

The parameters depend on the interface version and are not available in all units.

Appendix E. Declaration of Conformity

Declaration of Conformity



Type: GW 4 Series

Manufacturer Woodward Governor Company
Leonhard-Reglerbau GmbH

Handwerkstrasse 29
70565 Stuttgart - Germany

Tel: +49 (711) 789 54-0
Fax: +49 (711) 789 54-100

E-mail: sales-stuttgart@woodward.com

Type

GW 4 Series

Product description

INTERFACE CONVERTER FROM ONE HARDWARE TO ANOTHER AS WELL AS FROM ONE PROTOCOL TO ANOTHER. DIFFERENT COMBINATIONS AVAILABLE DEPENDING ON REQUIREMENTS.

The named product fulfills the following directives of the European Community:

73/23/EEC Low Voltage Switchgear Directive

"Council directive on the harmonization of the laws of member state relating to electrical equipment designed for use within certain voltage limits"

89/336/EEC Electromagnetic Compatibility Directive

"Council directive on the approximation of the laws of the member states relating to electromagnetic compatibility"

The conformity of the indicated product with the essential safety requirements of the standards is proven by the strict observation of the directives mentioned.



The company Woodward Governor Company Leonhard-Reglerbau GmbH, Handwerkstrasse 29, 70565 Stuttgart, Germany, has checked the product and provided it with the opposite indicated sign.

70565 Stuttgart, August 2, 2004

Gerd Zoellmer (Chief R+D Manager)

Druck/Printed 02.08.2004
Seite/Page 1 von/of 1

H:\00_Work\Ko_C-TICK\DoC\stordner\EG-Konformitätserklärungen\vorlage\GW 4 - Declaration of Conformity 2004-08-02.doc
© Woodward Governor Company Leonhard-Reglerbau GmbH Stuttgart +49 (0) 711 789 54-0

Declaration of Conformity

Type: GW 4 Series

European Norm	German Norm	VDE Classification	Description
73/23/EEC - Low Voltage Switchgear Directive			
EN 50178	DIN EN 50178 Edition: 1998-04	VDE 0160	Electronic equipment for use in electrical power installations and their assembly into electrical power installations
89/336/EEC - Electromagnetic Compatibility Directive			
EN 61000-6-4	DIN EN 61000-6-4 Edition: 2002-08	VDE 0839 Part 6-4	Electromagnetic compatibility (EMC) Part 6: Generic standards Section 4: Emission standard for industrial environments
EN 61000-6-2	DIN EN 61000-6-2 Edition: 2002-08	VDE 0839 Part 6-2	Electromagnetic compatibility (EMC); Part 6: Generic standards Section 2: Immunity for industrial environments
EN 61000-4-2	DIN EN 61000-4-2 Edition: 2001-12	VDE 0847 Part 4-2	Electromagnetic compatibility (EMC) Part 4: Testing and measuring techniques Section 2: Electrostatic discharge immunity test
EN 61000-4-3	DIN EN 61000-4-3 Edition: 2001-12	VDE 0847 Part 3	Electromagnetic compatibility (EMC) Basic Immunity Standard Part 4-3: Radiated, radio-frequency electromagnetic field – immunity test.
EN 61000-4-4	DIN EN 61000-4-4 Edition: 2002-07	VDE 0847 Part 4-4	Electromagnetic compatibility (EMC) Part 4: Testing and measuring techniques Section 4: Electrical fast transient/burst immunity test
EN 61000-4-5	DIN EN 61000-4-5 Edition: 2001-12	VDE 0847 Part 4-5	Electromagnetic compatibility (EMC) Part 4: Testing and measuring techniques Section 5: Surge immunity test
EN 61000-4-6	DIN EN 61000-4-6 Edition: 2001-12	VDE 0843 Part 4-6	Electromagnetic compatibility Basic immunity standard Part 6: Immunity to conducted disturbances, induced by radio frequency fields
EN 55011	DIN EN 55011 Edition: 2000-05	VDE 0875 Part 11	Suppression of radio disturbances caused by electrical appliances and systems; Limits and methods of measurement of radio disturbance characteristics of industrial, scientific and medical (ISM) radio-frequency equipment

Druck/Printed 02.08.2004
Seite/Page 2 von/of 2

H:\00_Work\Ko_C-TICKDoC\stordner\EG-Normfikt\serklärungenvorlage\GW 4 - Declaration of Conformity 2004-08-02.doc
© Woodward Governor Company Leonhard-Reglerbau GmbH Stuttgart +49 (0) 711 789 54-0

Appendix F. Service Options



Product Service Options



The following factory options are available for servicing Woodward equipment, based on the standard Woodward Product and Service Warranty (5-01-1205) that is in effect at the time the product is purchased from Woodward or the service is performed. If you are experiencing problems with installation or unsatisfactory performance of an installed system, the following options are available:

- Consult the troubleshooting guide in the manual.
- Contact Woodward technical assistance (see "How to Contact Woodward" later in this chapter) and discuss your problem. In most cases, your problem can be resolved over the phone. If not, you can select which course of action you wish to pursue based on the available services listed in this section.

Returning Equipment For Repair



If a control (or any part of an electronic control) is to be returned to Woodward for repair, please contact Woodward in advance to obtain a Return Authorization Number. When shipping the unit(s), attach a tag with the following information:

- name and location where the control is installed;
- name and phone number of contact person;
- complete Woodward part numbers (P/N) and serial number (S/N);
- description of the problem;
- instructions describing the desired repair.



CAUTION

To prevent damage to electronic components caused by improper handling, read and observe the precautions in Woodward manual 82715, *Guide for Handling and Protection of Electronic Controls, Printed Circuit Boards, and Modules*.

Packing a Control

Use the following materials when returning a complete control:

- protective caps on any connectors;
- antistatic protective bags on all electronic modules;
- packing materials that will not damage the surface of the unit;
- at least 100 mm (4 inches) of tightly packed, industry-approved packing material;
- a packing carton with double walls;
- a strong tape around the outside of the carton for increased strength.

Return Authorization Number RAN

When returning equipment to Woodward, please telephone and ask for the Customer Service Department in Stuttgart [+49 (0) 711 789 54-0]. They will help expedite the processing of your order through our distributors or local service facility. To expedite the repair process, contact Woodward in advance to obtain a Return Authorization Number, and arrange for issue of a purchase order for the unit(s) to be repaired. No work can be started until a purchase order is received.



NOTE

We highly recommend that you make arrangement in advance for return shipments. Contact a Woodward customer service representative at +49 (0) 711 789 54-0 for instructions and for a Return Authorization Number.

Replacement Parts



When ordering replacement parts for controls, include the following information:

- the part numbers P/N (XXXX-XXX) that is on the enclosure nameplate;
- the unit serial number S/N, which is also on the nameplate.

How To Contact Woodward



Please contact following address if you have questions or if you want to send a product for repair:

Woodward GmbH
Handwerkstrasse 29
70565 Stuttgart - Germany

Phone: +49 (0) 711 789 54-0 (8:00 - 16:30 German time)
Fax: +49 (0) 711 789 54-100
E-mail: stgt-info@woodward.com

For assistance outside Germany, call one of the following international Woodward facilities to obtain the address and phone number of the facility nearest your location where you will be able to get information and service.

Facility	<u>Phone number</u>
USA	+1 (970) 482 5811
India	+91 (129) 409 7100
Brazil	+55 (19) 3708 4800
Japan	+81 (476) 93 4661
The Netherlands	+31 (23) 566 1111

You can also contact the Woodward Customer Service Department or consult our worldwide directory on Woodward's website (www.woodward.com) for the name of your nearest Woodward distributor or service facility. [For worldwide directory information, go to www.woodward.com/ic/locations.]

Engineering Services



Woodward Industrial Controls Engineering Services offers the following after-sales support for Woodward products. For these services, you can contact us by telephone, by e-mail, or through the Woodward website.

- Technical support
- Product training
- Field service during commissioning

Technical Support is available through our many worldwide locations, through our authorized distributors, or through GE Global Controls Services, depending on the product. This service can assist you with technical questions or problem solving during normal business hours. Emergency assistance is also available during non-business hours by phoning our toll-free number and stating the urgency of your problem. For technical engineering support, please contact us via our toll-free or local phone numbers, e-mail us, or use our website and reference technical support.

Product Training is available on-site from several of our worldwide facilities, at your location, or from GE Global Controls Services, depending on the product. This training, conducted by experienced personnel, will assure that you will be able to maintain system reliability and availability. For information concerning training, please contact us via our toll-free or local phone numbers, e-mail us, or use our website and reference *customer training*.

Field Service engineering on-site support is available, depending on the product and location, from our facility in Colorado, or from one of many worldwide Woodward offices or authorized distributors. Field engineers are experienced on both Woodward products as well as on much of the non-Woodward equipment with which our products interface. For field service engineering assistance, please contact us via our toll-free or local phone numbers, e-mail us, or use our website and reference *field service*.

Technical Assistance



If you need to telephone for technical assistance, you will need to provide the following information. Please write it down here before phoning:

Contact

Your company _____

Your name _____

Phone number _____

Fax number _____

Control (see name plate)

Unit no. and revision: P/N: _____ REV: _____

Unit type _____

Serial number S/N _____

Description of your problem

Please be sure you have a list of all parameters available. You can print this using LeoPC1. Additionally you can save the complete set of parameters (standard values) and send them to our Service department via e-mail.

We appreciate your comments about the content of our publications.
Please send comments to: stgt-documentation@woodward.com
Please include the manual number from the front cover of this publication.



Woodward GmbH
Handwerkstrasse 29 - 70565 Stuttgart - Germany
Phone +49 (0) 711 789 54-0 • Fax +49 (0) 711 789 54-100
stgt-info@woodward.com

Homepage

<http://www.woodward.com/power>

Woodward has company-owned plants, subsidiaries, and branches, as well as authorized distributors and other authorized service and sales facilities throughout the world.

Complete address/phone/fax/e-mail information
for all locations is available on our website (www.woodward.com).

2008/11/Stuttgart